

Ninja-Lite BB Installation Instructions



IMPORTANT NOTICE:

- Do not alter this product in any way as it can cause unseen damage. Any modifications to this product will void the warranty.
- TOKEN suggests taking your bottom bracket to your local authorized TOKEN dealer for installation, service and adjustments.
- Read the user's guide before installation and use. Follow all instructions carefully. If you have any questions, don't ride the bike. Take it to your local TOKEN dealer for assistance.

BEFORE RIDING:

- Check that there is no side-to-side movement in the bottom bracket. Also check that the cranks spin smoothly. If there is movement or the bottom bracket is not smooth, take the bicycle to your local TOKEN dealer for service or replacement.
- Ensure that the cranks are firmly attached to the bottom bracket. Improperly attached cranks can become detached from the bicycle and serious injury can result. Never ride a bicycle with improperly attached cranks.

AFTER RIDING:

- When cleaning the bottom bracket, only use mild soap and water. Never spray the bottom bracket with high-pressure water. Water can enter the bottom bracket and cause it to wear prematurely.

WARRANTY:

All TOKEN products are guaranteed against defects in materials or workmanship for two (2) years from the original date of purchase. This warranty applies to the original owner only and is not transferable. The warranty is considered void if resold. The warranty does not cover normal wear and tear or damage from abuse. Please see our website or contact your local dealer or distributor for more details.

Step 1

Apply thin layer of grease to BB cups as shown in the diagram.

Step 2

Thread the ① drive side cup clockwise into the ② non-drive side cup by hand until the BB cups touch the bottom bracket shell.

Step 3

Use a torque wrench with the ② BB Installation Tool (sold separately) to tighten to 12-14 N.m (106-124 in-lb).

NOTE

- We recommend using ② BB Installation Tool (sold separately) for easier installation, and to prevent any frame or BB cup damage.



WARNING

- 12-14 N.m (106-124 in-lb) of tightening torque is sufficient to lock the BB cups in place. Never exceed the torque limitation as it could damage the composite BB cups permanently.

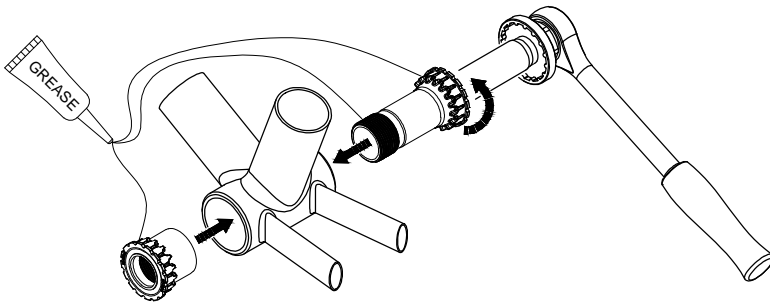

www.tokenproducts.com

SHIMANO MTB / ROAD CRANKSET

MODEL: BB38624PS

No.	Description	Q'ty
1	Right Cup	1
2	Left Cup	1
3	0.6mm Spacer	1
4	1mm Spacer	1

NOTICE

- Installation tool TF4630-3SPA-2/2 or BBT-27.2 is sold separately.

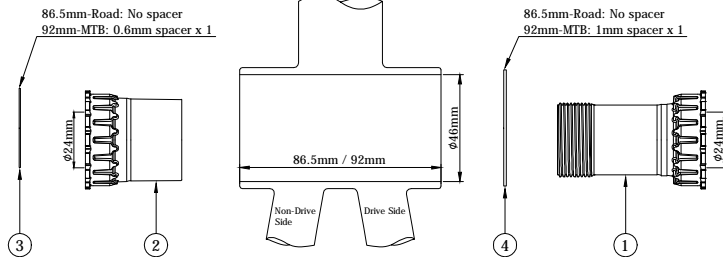

SRAM GXP MTB / ROAD CRANKSET

MODEL: BB38624PR

No.	Description	Q'ty
1	Right Cup	1
2	Left Cup	1
3	0.6mm Spacer	2
4	1mm Spacer	2
5	2.5mm Spacer	1
6	GXP Adaptor	1
7	Wave Washer	1

NOTICE

- Installation tool TF4630-3SPA-2/2 or BBT-27.2 is sold separately.

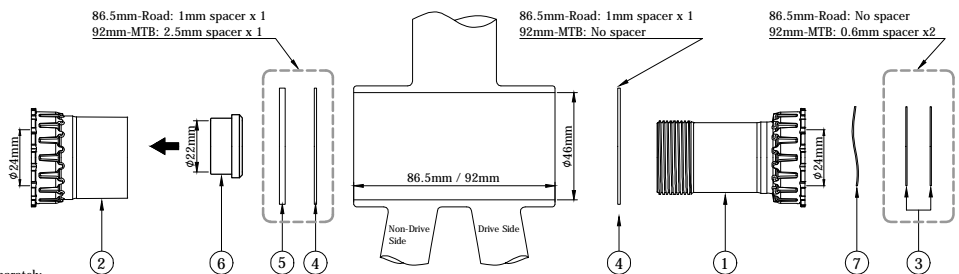

SRAM DUB MTB / ROAD CRANKSET

MODEL: BB38629P

No.	Description	Q'ty
1	Right Cup	1
2	Left Cup	1
4	1mm Spacer	1
8	2mm Spacer	1

NOTICE

- Installation tool TF4630-3SPA-2/2 or BBT-27.2 is sold separately.

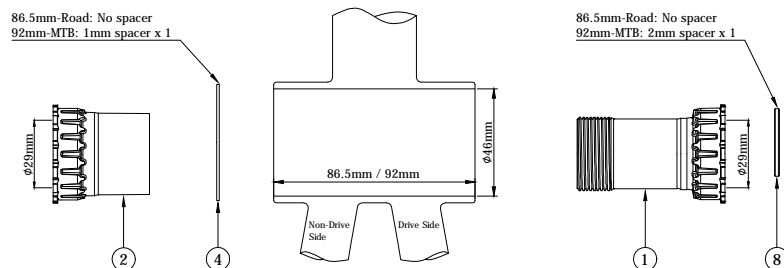

BB386 FRAME (φ46 x 86.5mm) / BB392 FRAME (φ46 x 92 mm)

BB386 / BB392 CRANKSET

MODEL: BB38630P

No.	Description	Q'ty
1	Right Cup	1
2	Left Cup	1
4	1mm Spacer	1
5	2.5mm Spacer	2
9	Wave Washer	1
10	2mm Spacer	1

86.5mm Road-SRAM BB386: 2.5mm x1 + 1mm spacer x1
 86.5mm Road-FSA BB386: No spacer
 92mm MTB-FSA BB392: 1mm spacer x1

86.5mm Road-SRAM BB386: 2.5mm spacer x1
 86.5mm Road-FSA BB386: No spacer
 92mm MTB-FSA BB392: No spacer

86.5mm Road-FSA BB386: Wave Washer x1
 92mm MTB-FSA BB392: Wave Washer x1

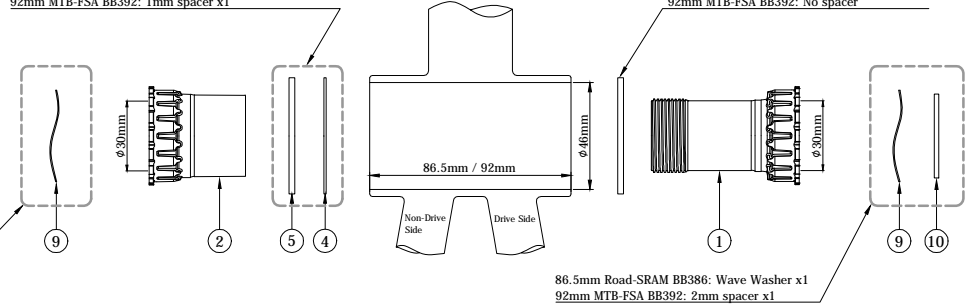

NOTICE

- Installation tool TF4630-3SPA-2/2 or BBT-27.2 is sold separately.

EASTON EC90SL ROAD CRANKSET (with EC129 spindle)

MODEL: BB38630P

No.	Description	Q'ty
1	Right Cup	1
2	Left Cup	1
11	3mm Spacer	2

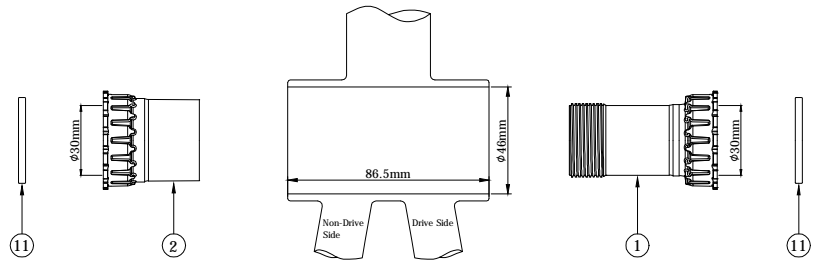

NOTICE

- Installation tool TF4630-3SPA-2/2 or BBT-27.2 is sold separately.

ROTOR ROAD CRANKSET

MODEL: BB38630P

No.	Description	Q'ty
1	Right Cup	1
2	Left Cup	1
10	2mm Spacer	2

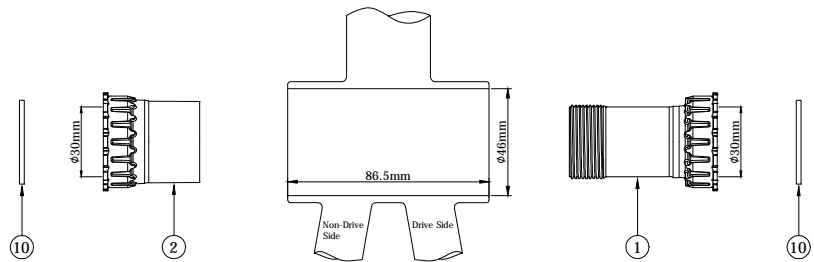

NOTICE

- Installation tool TF4630-3SPA-2/2 or BBT-27.2 is sold separately.

RACEFACE Cinch-134 MTB CRANKSET

MODEL: BB38630P

No.	Description	Q'ty
1	Right Cup	1
2	Left Cup	1
11	3mm Spacer	2

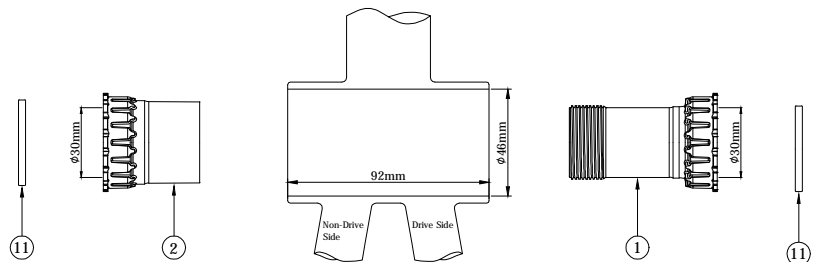

NOTICE

- Installation tool TF4630-3SPA-2/2 or BBT-27.2 is sold separately.

BB386 FRAME (φ46 x 86.5mm) / BB392 FRAME (φ46 x 92 mm)