

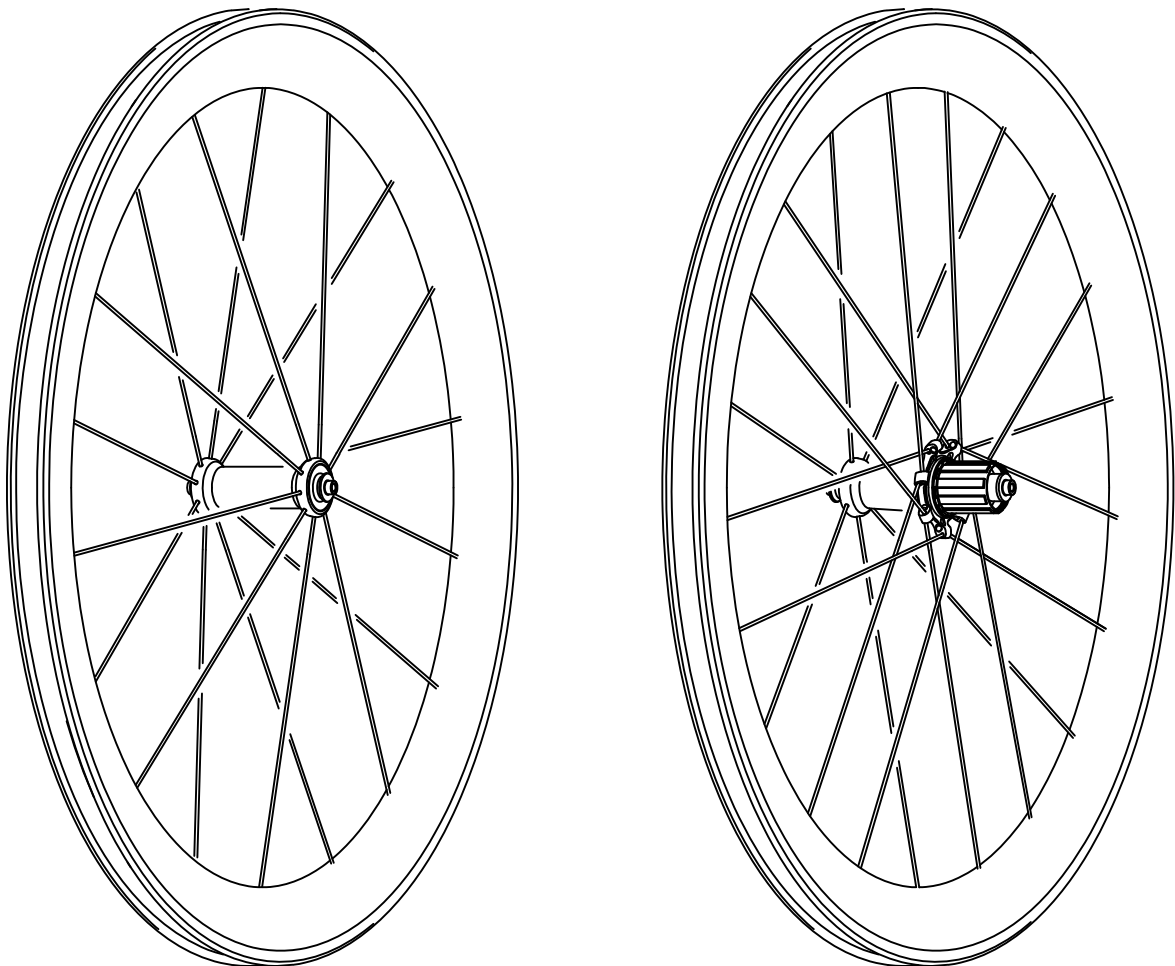

**VENTOUS
KONAX PRO
KONAX TRI**

ZENITH Carbon Clincher

ROAD RACING WHEELSET



SPECIFICATION

	RIM				HUB	SPOKE / NIPPLE	CASSETTE BODY	WHEEL MAXIMUM
	Profile Depth	Internal Width	Brake Track Width	Recom'ed Tyre Size	Z1 Hubset F-18H R-21H DSP 2:1 TFT Bearing	SAPIM CX-RAY Black Spoke Alloy External Black Nipple	Shi & SRAM 10-11S - or - SRAM XDR	Inflation Pressure 115psi (700x25c) Rider Weight 100kg
VENTOUS KONAX PRO KONAX TRI	36mm 52mm 76mm	20mm	27.4mm	700x25c 700x28c				

WARNING

1. Use only TOKEN brand carbon-rim specified brake pads on rims with carbon fiber brake track. Use other brake pads could degrade braking performance and may lead to unwanted character such as noise and heat accumulation, and will void the warranty.
2. On carbon rims, brake pad should always be placed 3mm below the outer edge of the rim.
3. Over tensioning spokes and exceeding maximum inflation pressure could cause unseen damage. Note that overly inflated tyres don't necessarily have lower rolling resistance, and may have inferior traction!
4. Discontinue use of rim immediately if the brake track is worn, deformed (carbon) or the wear indication dots disappear (alloy).
5. Mounting clincher tyres on tubeless-ready rims could take more effort than on regular rims. Take great care not to damage any part of the rim with tyre lever! Applying mild soap water or tyre sealant on rim and tyre bead could make tyre installation easier.
6. Make sure your tyre-and-wheel combination meets ISO 4210-6 Safety Requirement regulation - there should always be a clearance no less than 4mm between the tyre and the frame, as well as other components such as brake caliper.
7. Failure to follow the conditions listed above may result in 2-year warranty being voided. Contact your local dealer or see the TOKEN website for details. -www.tokenproducts.com-

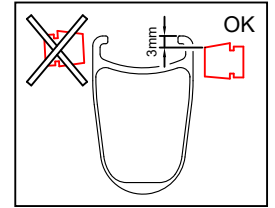

HUBS

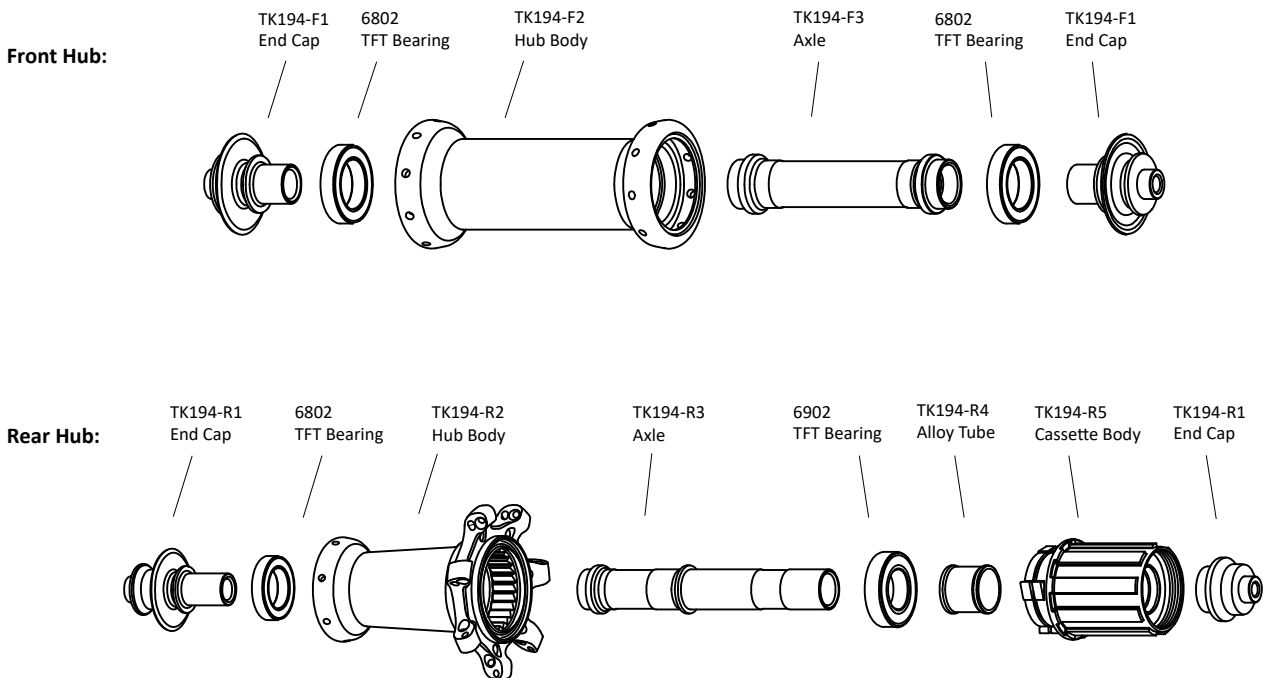

WHEEL BUILDING

RIM

BEARING

Spoke Information	Tension (kgf)	Size	Length (mm)			ERD (mm)	Front	Rear
			VENTOUS	KONAX PRO	KONAX TRI			
Front	100~120	14G	272	256	232	VENTOUS 567 KONAX PRO 535 KONAX TRI 487	6802TFT * 2	6802TFT * 1 6902TFT * 3
Rear	Drive Side	120~140	280	264	240			
	Non-Drive Side	80~100	274	258	234			